

轮片特点

轮面材料:	超级聚氨酯	轮芯材料:	高强度聚丙烯
轴 承:	双滚珠	胎面硬度:	95A±3
建议温度:	-20°C~50°C	运行速度:	4km/h

注意: 超出建议温度范围或超出建议速度使用, 可能会缩短产品使用寿命甚至损坏产品。

- ✔ 精密双轴承, 转动灵活
- ✔ 注塑聚氨酯材质, 锁扣式注塑成型, 耐油, 耐磨
- ✔ 环保静音, 有效保护地面
- ✔ 配金属护盖, 防缠绕
- ⚠ 潮湿高温环境会缩短使用寿命









运行省力	■■■■■□	良好
磨损寿命	■■■■■	优秀
静音效果	■■■■■□	良好
地面保护	■■■■■□	良好

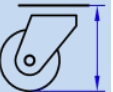

支架特点

- ✔ ON/OFF双踏板结构, 踩踏方便, 制动效果出色
- ✔ 碳钢压制成型, 坚固结实
- ✔ 加厚底板, 抗压不易变形
- ✔ 花铆接结构, 间隙紧密, 结构强度高
- ✔ 防尘圈有效保护油脂润滑, 避免灰尘等杂质进入
- ✔ 环保蓝白锌处理, 不含六价铬, 盐雾测试满足72小时以上

外形尺寸 (mm)	 载重	 轮径	 轮宽	 全高	 偏心距 F	 旋转半径 r	 旋转半径 R
3"	110 kg	75	32	108	34	71.5	116.5
4"	140 kg	100	32	135	32	82	116
5"	150 kg	125	32	160	32	94.5	121

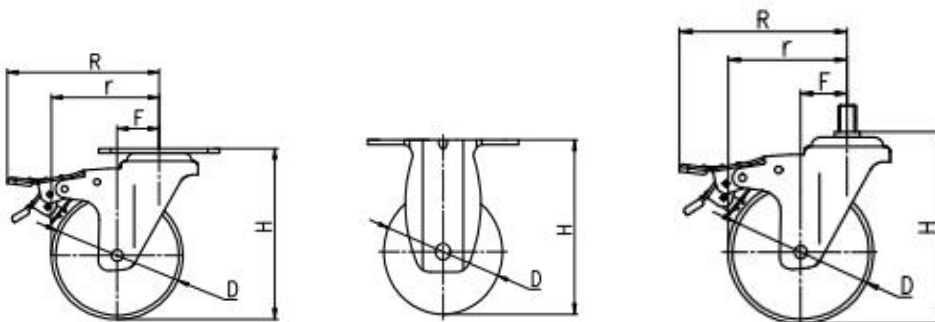

[中文简体]

安装尺寸

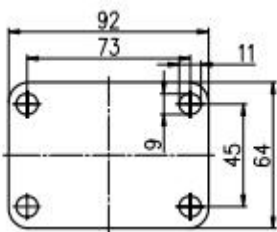

平底活动/刹车底板

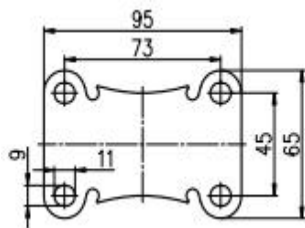

平底固定底板

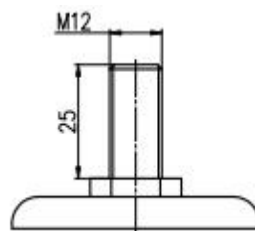

丝杆

产品代码					
产品图片					
轮径	平板万向	平板定向	平板刹车	丝杆万向	丝杆刹车
3"	20A01-0370	20AB1-0370	20A3B-0370	20A04-0370	20A7B-0370
4"	20A19-0371	20AB3-0371	20A5B-0371	20A22-0371	20A9B-0371
5"	20A28-0372	20AB4-0372	20A6B-0372	20A31-0372	20A1B-0372

产品特征



ON/OFF刹车，制动退刹便捷。

花式铆接，间隙紧密，结构稳定，防尘圈保护，有效防尘，保护油脂润。



支架表面蓝白锌处理，可满足盐雾试验72小时。

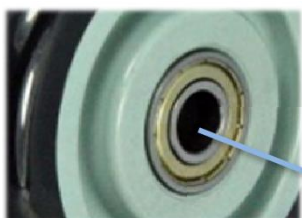

双滚珠精密轴承，转动灵活。

同款轮片

PUPS



PUPA

